

YAMAHA

VCD-100K

NATURAL SOUND VIDEO-CD CHANGER

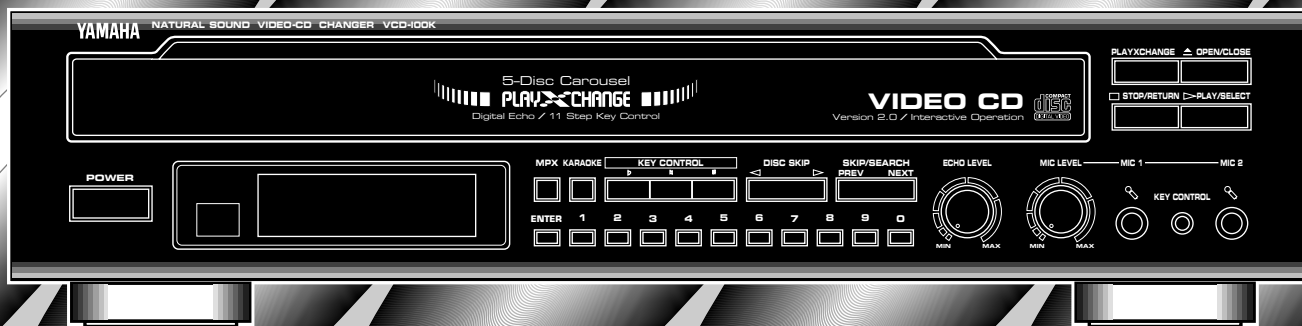

自然音小影碟转换器



OWNER'S MANUAL

使用说明书

This unit can play discs of the following types only.

Type of disc	Mark printed on the disc	Type of signal recorded	Size (Dimension)	Maximum possible play time
Video-CD	 	Sound + Picture (Movie)	12 cm	74 minutes
			8 cm (Single type)	20 minutes
Compact disc		Sound only	12 cm	74 minutes
			8 cm (Single type)	20 minutes

Never attempt to load a disc other than above into the unit because it may cause a damage to this unit and/or other units connected to this unit.

VIDEO-CD

Video-CDs are classified into two types, version 1.1 and 2.0. This unit can play not only discs of version 1.1, but also version 2.0 on which a Playback Control can be made.

Video-CD, version 1.1: With the same operation as compact discs, you can enjoy sounds and pictures (movies).

Video-CD, version 2.0: In addition to a normal play which is the same as discs of version 1.1, you can make a Playback Control. (For details on Playback Control, refer to page 16.)

FEATURES

- **5-Disc Carousel Auto-Changer (for Playing Video-CDs and Compact Discs)**
- **Full Opening Disc Tray for Changing 5 Discs at a Time**
- **PLAYXCHANGE; Disc Changing Capability while Playing Another**
- **Random Access Programmable Play**
- **Playback Control Function Available for Video-CDs, Version 2.0**
- **Automatic Pause Inserting Function for Karaoke (Karaoke Mode)**
- **Audio Output Mode Selector (MPX) Button for Karaoke**
- **11 Step Key Level Control Buttons**
- **Mic Level and Echo Level Controls**
- **Video Output Format Selector (VIDEO OUT MODE SELECT) Switch**
- **Two MIC Jacks and a Mini-Jack for Connecting with a Key Control Function of a Microphone**
- **Remote Control Capability**

CONTENTS

Caution	3	Playback Control of Video-CD (Ver. 2.0)	16
Connections	4	Notes about the Remote Control Transmitter	19
Controls and Their Functions	6	Handling Compact Discs	19
Basic Operations	9	Troubleshooting	20
Pre-Programming Selections (for Singing Karaoke)	13	Specifications	20

CAUTION: READ THIS BEFORE OPERATING YOUR UNIT.

- 1 To ensure the finest performance, please read this manual carefully. Keep it in a safe place for future reference.
- 2 Install your unit in a cool, dry, clean place – away from windows, heat sources, and too much vibration, dust, moisture or cold. Avoid sources of hum (transformers, motors). To prevent fire or electrical shock, do not expose to rain or water.
- 3 Do not operate the unit upside-down. It may overheat, possibly causing damage.
- 4 Never open the cabinet. If a foreign object drops into the unit, contact your dealer.
- 5 This player should not be placed on appliances, such as amplifiers, that produce heat, or placed in a cabinet that impedes the flow of air. This may result in a failure in this player. Install the player in a well ventilated place. In addition, do not place objects on the player.
- 6 Do not use force on switches, knobs or cords. When moving the set, first turn the unit off. Then gently disconnect the power plug and the cords connecting to other equipment. Never pull the cord itself.
- 7 Do not attempt to clean the unit with chemical solvents; this might damage the finish. Use a clean, dry cloth.
- 8 Be sure to read the "TROUBLESHOOTING" section on common operating errors before concluding that your unit is faulty.
- 9 To prevent lightning damage, unplug the power cord and remove the antenna cable during electrical storms.
- 10 The generated digital signals may interfere with other equipment such as tuners or receivers. Move the system farther away from such equipment if interference is observed.
- 11 **Voltage selector (General model only)**
The voltage selector (on the rear panel of this unit) must be correctly set to the voltage used locally before making any connection to the AC power supply.

The unit is not disconnected from the AC power source as long as it is connected to the wall outlet, even if the unit itself is turned off.

NOTE:

Please check the copyright laws in your country before recording from records, compact discs, radio, etc. Recording of copyrighted material may infringe copyright laws.

WARNING

To reduce the risk of fire or electric shock, do not expose this unit to rain or moisture.

To avoid electrical shock, do not open the cabinet. Refer servicing to qualified personnel only.

DANGER

Invisible laser radiation when open and interlock failed or defeated.
 Avoid direct exposure to beam.

CAUTION

Use of controls or adjustments or performance of procedures other than those specified herein may result in hazardous radiation exposure.

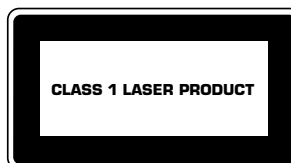

This compact disc player is classified as a CLASS 1 LASER product. The CLASS 1 LASER PRODUCT label is located on the rear exterior. (China model only)

Laser component in this product is capable of emitting radiation exceeding the limit for Class 1.

CAUTION

As the laser beam used in this compact disc player is harmful to the eyes, do not attempt to disassemble the cabinet. Refer servicing to qualified personnel only.

Laser Diode Properties

- Material: GaAIAs
- Wavelength: 780nm
- Emission Duration: continuous
- Laser Output: max. 44.6μW*

* This output is the value measured at a distance of about 200mm from the objective lens surface on the Optical Pick-up Block.

CAUTION FOR CARRYING THIS UNIT

Be sure not to carry or tip the unit with discs remaining in it.

CAUTION FOR MOVING THIS UNIT

When moving this unit, first remove all discs from the disc tray and close the tray by pressing the **OPEN/CLOSE** button, and then switch off the power after you confirm that the display indicates as follows.

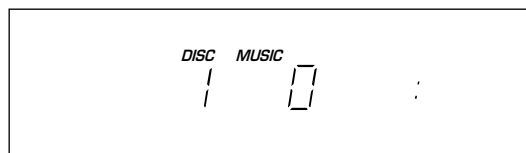

Never switch off the power if the display is not pictured as above, otherwise the unit will break down during moving because the internal mechanism is not locked.

CONNECTIONS

- Before making any connections, switch OFF the power to this unit, the amplifier, the video monitor, etc.
- Connections should be made to the correct input terminals of the amplifier, the video monitor, etc.
- If the placement of this unit causes interference to other equipment, separate them from each other.

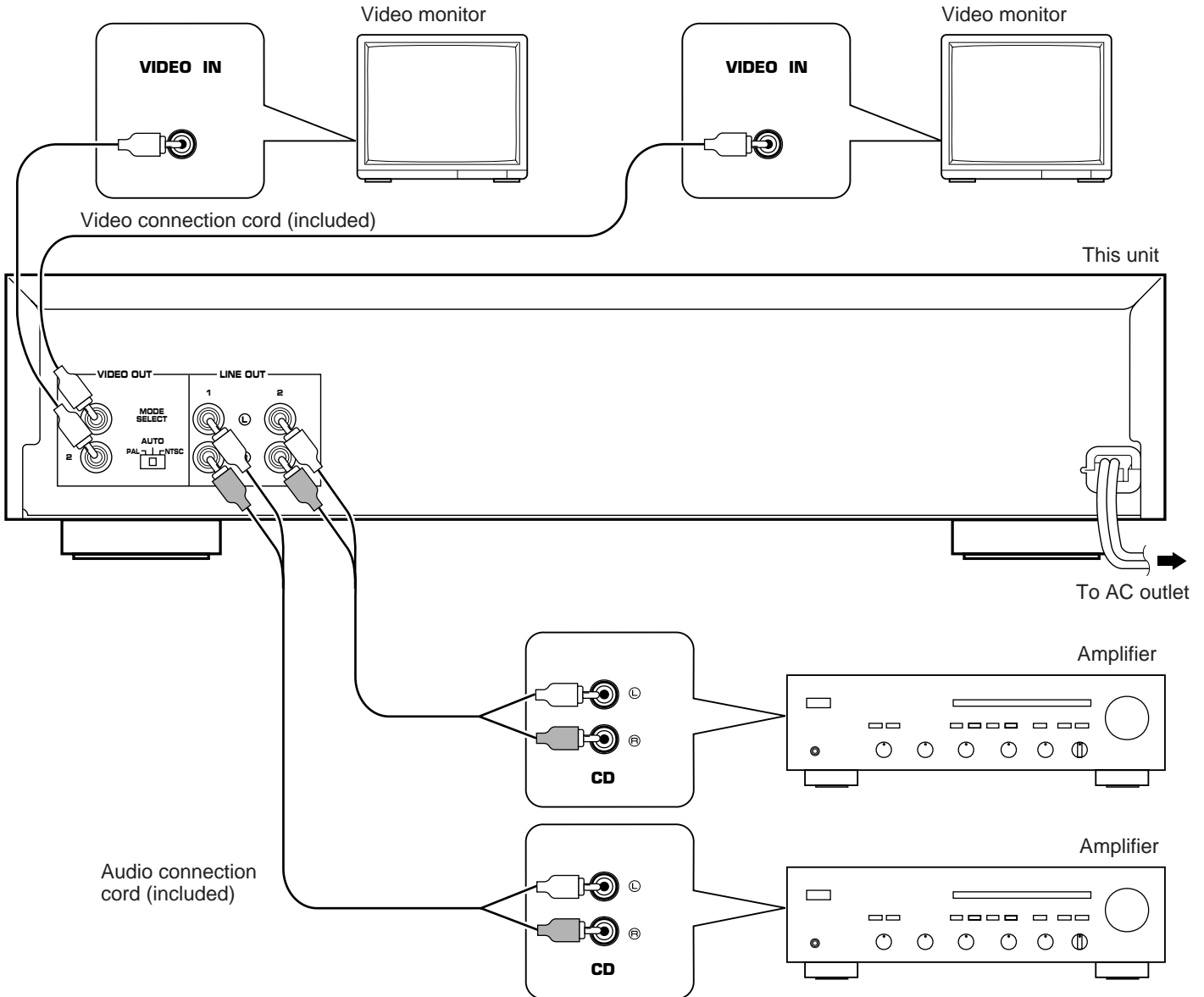

Connecting to the amplifier

This unit is equipped with 2 sets of LINE OUT terminals to allow you to connect one or two amplifiers to this unit.

Connect the LINE OUT terminals to the audio input terminals of the amplifier (marked as "CD", "AUX", etc.) by using the included audio connection cord.

Be sure that the left ("L") and right ("R") LINE OUT terminals are connected to the corresponding (left and right) terminals of the amplifier.

Connecting to the video monitor

This unit is equipped with 2 VIDEO OUT terminals to allow you to connect one or two video monitors to this unit.

Connect this unit's VIDEO OUT terminal to the video input terminal of the video monitor by using the included video connection cord.

* This product includes one audio connection cord and one video connection cord.

Setting the VIDEO OUT MODE SELECT switch

This unit is designed for use with the NTSC and PAL television formats. Set this switch to the position suitable for the use of this unit you plan.

PAL: Outputs signals in the PAL format no matter which format (PAL or NTSC) the currently playing disc employs.
Set to this position if your video monitor employs the PAL format.

AUTO: Outputs signals in the same format as the currently playing disc employs.
Set to this position if your video monitor can be switched in between the PAL and NTSC formats automatically.

NTSC: Outputs signals in the NTSC format no matter which format (PAL or NTSC) the currently playing disc employs.
Set to this position if your video monitor employs the NTSC format.

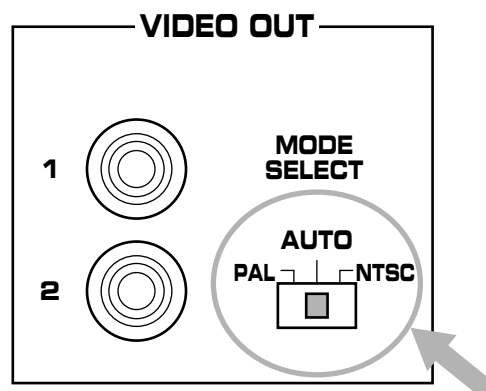

Connecting microphones for singing Karaoke

One or two microphones can be connected to this unit. Moreover, if you have a Yamaha microphone which has a key control function, connect the mini-plug connector cable of the microphone to the **KEY CONTROL** jack of this unit. This connection allows you to change key of source sound by using controls on the microphone.

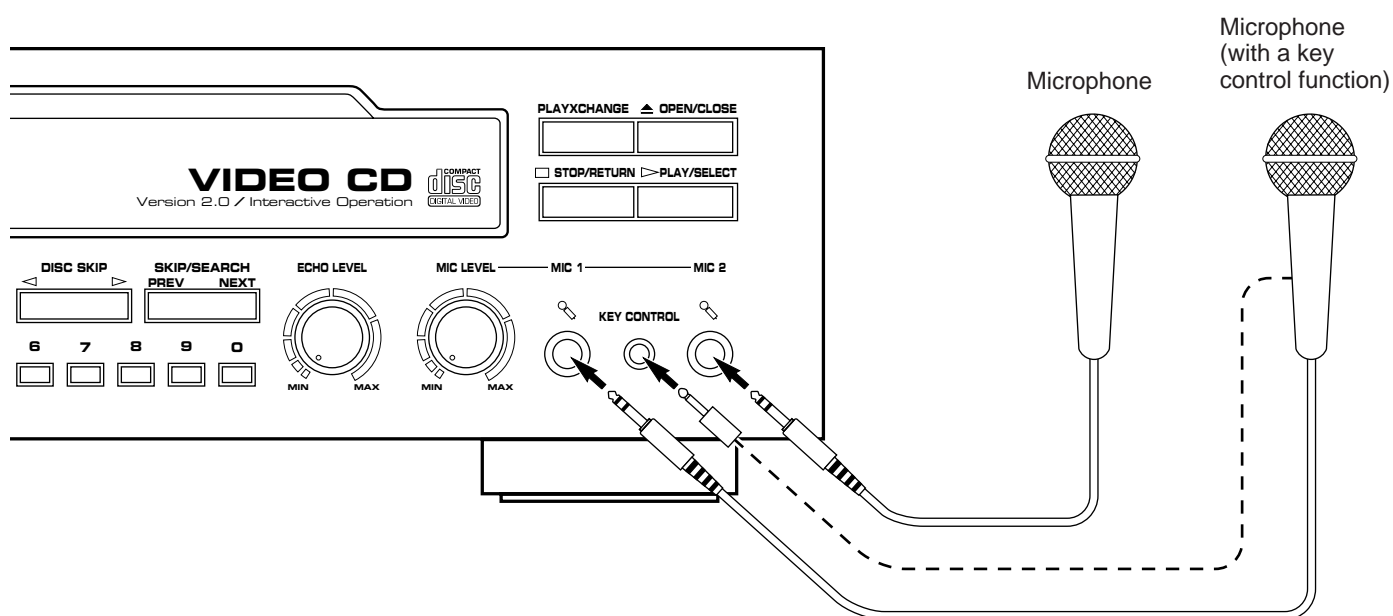

CONTROLS AND THEIR FUNCTIONS

FRONT PANEL

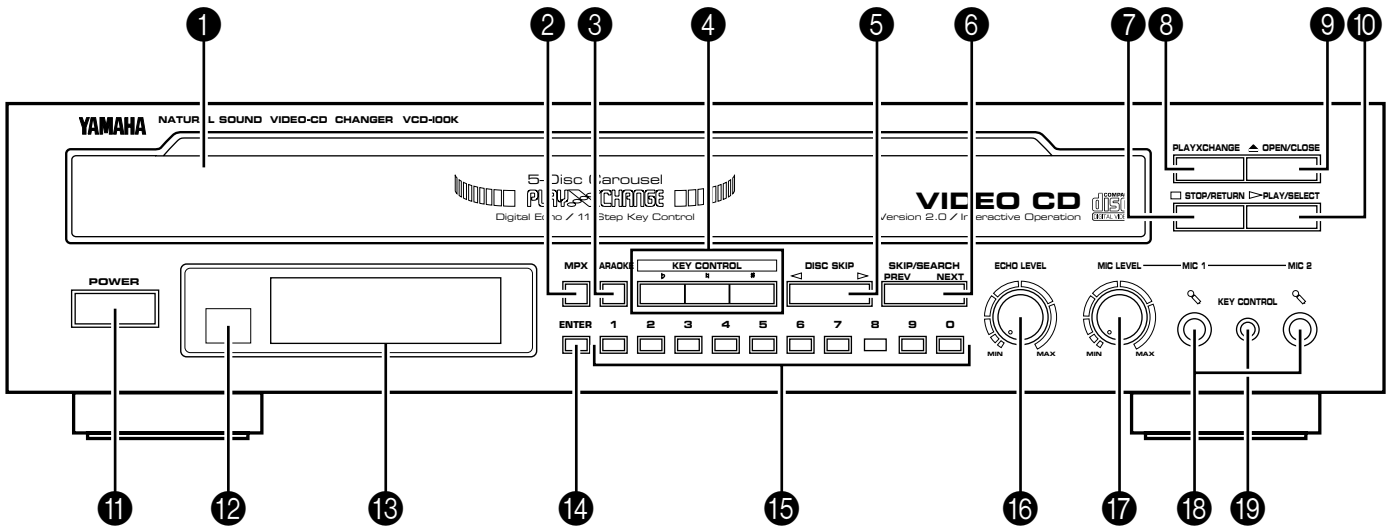

REMOTE CONTROL TRANSMITTER

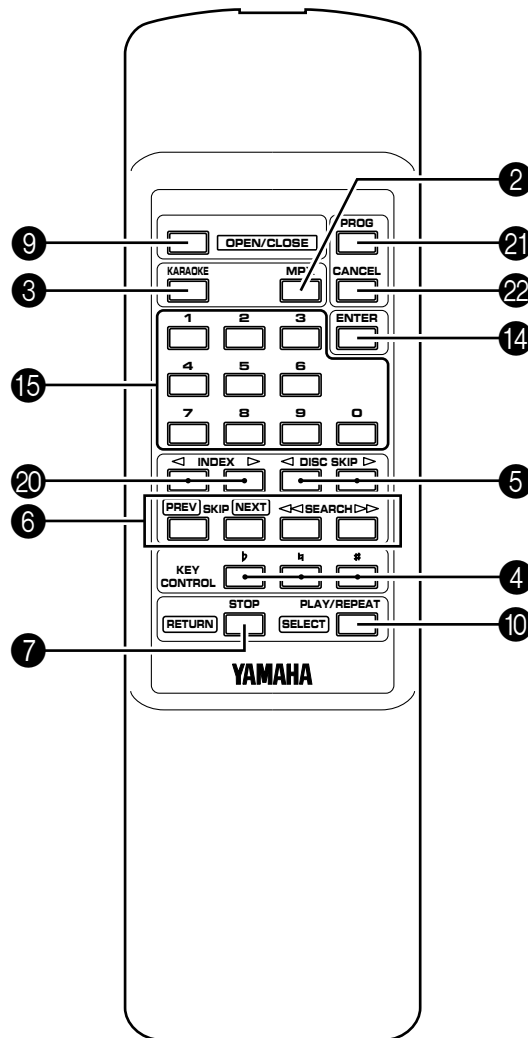

1 Disc tray

Up to 5 discs can be loaded on the disc tray. Five disc-setting positions on the disc tray are numbered from 1 to 5.

2 MPX button

Whenever this button is pressed, audio output mode changes. The currently selected audio output mode is shown on the display. (Refer to page 12 for details.)

3 KARAOKE button

When this button is pressed so that "KARAOKE" lights up on the display, a pause is inserted each time a play of track ends. Pressing this button once more will cancel this function.

4 KEY CONTROL buttons



These buttons are available when a microphone is connected to this unit. Pressing these buttons changes key of the track currently playing. The current key level is shown on the display.

 : Whenever pressed, key of the track becomes lower.

 : Pressing this button restores the original key level of the track.

 : Whenever pressed, key of the track becomes higher.

5 DISC SKIP button(s)

Whenever this button is pressed, the disc tray rotates and the selected disc changes. Pressing the  side rotates the disc tray clockwise and pressing the  side rotates the disc tray counterclockwise.

6 SKIP/SEARCH (PREV and NEXT) buttons

SKIP: Pressing this button locates the beginning of the next track (or the currently playing track or the previous track).

SEARCH:

Pressing and holding this button advances (or reverses) the play rapidly.

PREV and NEXT:

Functions only when a Playback Control operation is made on a Video-CD, version 2.0. Pressing the **NEXT** side selects the next display mode, and pressing the **PREV** side restores the previous display mode.

* For some discs, this key operation will not function.

7 STOP/RETURN button

Stops playing a disc during a normal disc play. During a Playback Control operation, press this button to return to a previous screen menu mode.

When playing a Video-CD, pressing this button calls a Playback Control mode.

8 PLAYXCHANGE button

Press this button to open and close the disc tray while playing a disc. This is useful when you want to exchange discs while playing another disc.

9 OPEN/CLOSE button

Opens and closes the disc tray.

10 PLAY/SELECT (PLAY/REPEAT) button

Pressing this button starts a disc play. If this button is pressed while playing a disc, play will restart from the beginning of the track currently playing.

When this unit is in a Playback Control mode, pressing this button selects a screen menu mode.

11 POWER switch

Press this switch to switch the power on. Press it again to switch the power off.

12 Remote control sensor

Receives signals from the remote control transmitter.

13 Display panel

See page 8.

14 ENTER button

Used for programming tracks. (Refer to page 13 for details.)

15 Numeric buttons

Used to select a track number.

16 ECHO LEVEL control

This control adjusts the level of echo applied to sound signals input from the microphone(s) connected to this unit's **MIC** jacks.

17 MIC LEVEL control

This control adjusts the level of sound signals input from the microphone(s) connected to this unit's **MIC** jacks.



18 MIC (1 and 2) jacks

One or two microphones can be connected to these jacks.

19 KEY CONTROL jack

If you have a Yamaha microphone which has a key control function, connect the mini-plug connector cable of the microphone to this jack. This connection allows you to change key of source sound by using controls on the microphone.

20 INDEX buttons

If the selected disc has index numbers, by pressing the  or  button once or more, you can select a desired index number and play the disc from that point.

21 PROG button

This button is available only when "KARAOKE" is illuminated on the display. This button is used for programming tracks. (Refer to page 13 for details.)

22 CANCEL button

Used to cancel a programmed track or all program data. (Refer to page 14–15 for details.)

DISPLAY PANEL

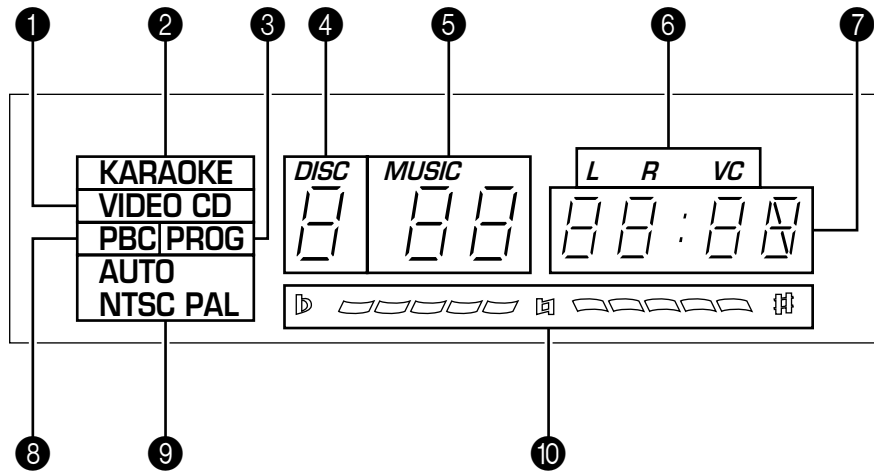

1 VIDEO CD indicator

Lights up when the selected disc is a Video-CD.

2 KARAOKE indicator

Lights up when the KARAOKE function is turned on by pressing the **KARAOKE** button, and goes off if the **KARAOKE** button is pressed once more.

3 PROG indicator

Lights up when this unit is in the program play mode.

4 Disc number indicator (DISC)

Shows the disc number of selected disc.

5 Track number indicator (MUSIC)

Shows the selected track number.

6 Audio output mode indicators

The current audio output mode selected by pressing the **MPX** button is shown by these indicators. (Refer to page 12 for details.)

7 Time display

Shows elapsed time of the track currently playing, program number and so on.

8 PBC (Playback Control) indicator

Lights up when this unit is in a Playback Control mode for playing a Video-CD, version 2.0.

9 Video signal output mode indicators

Show the current position of the **VIDEO OUT MODE SELECT** switch on the rear panel and the format of video output signal.

10 Key level indicator

Shows the key level of the source currently playing in 11 steps.

- ▶ : Lights up when the current key level is lower than the original level of the track.
- ◻ : Lights up when the current key level is the original level of the track.
- ◼ : Lights up when the current key level is higher than the original level of the track.

This manual mainly describes how to operate this unit by using the remote control transmitter. To operate this unit from the front panel, use the same named buttons on the front panel.

BASIC OPERATIONS

Loading discs and starting disc play

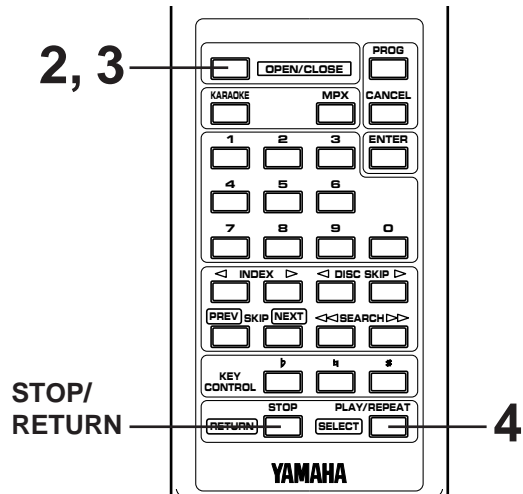
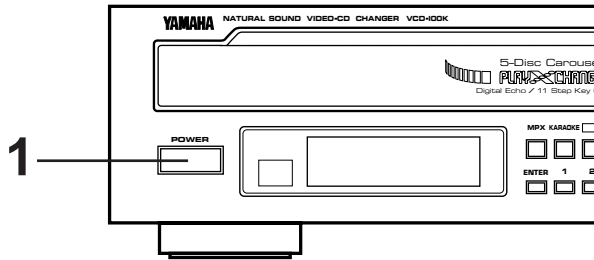

1 Turn the power on. **POWER**

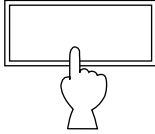

2 Open the disc tray and load discs.

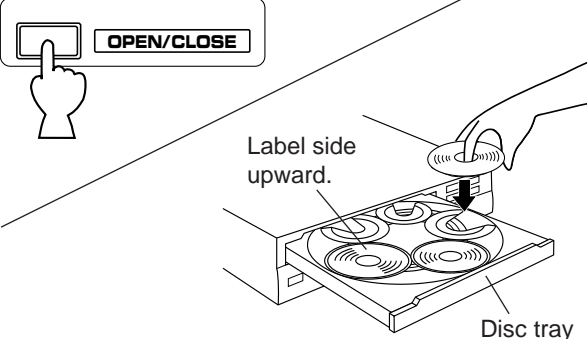

Label side upward.

Disc tray

3 Close the disc tray.

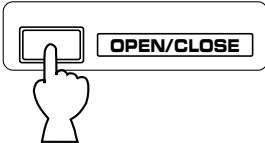

4 Start a disc play.

PLAY/REPEAT

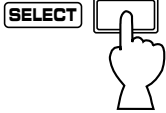

Play will begin from the first track of Disc 1 automatically.
* If you want to play a desired track on another disc, see the next page.

To stop play

STOP



This unit stops at the beginning of the first track on the disc.

Note
If the **STOP/RETURN** button is not pressed (except when "KARAOKE" is illuminated on the display), play will not stop until the last track on the last-numbered disc has been played.

Exchanging discs while playing another disc
During play, you can open the disc tray by pressing the **PLAYXCHANGE** button without interrupting disc play. In this case, pressing the **DISC SKIP** button has no effect.

Note
Additionally, you can close the disc tray by the following ways. If the tray is closed by these ways, play will begin automatically.

- Press the **PLAY/SELECT** button. (Play will begin from the first track of Disc 1.)
- Press a numeric button, and then press the **PLAY/SELECT** button or the **ENTER** button.
- Press the front edge of the disc tray gently. (Play will begin from the first track of Disc 1.)

To play a desired track

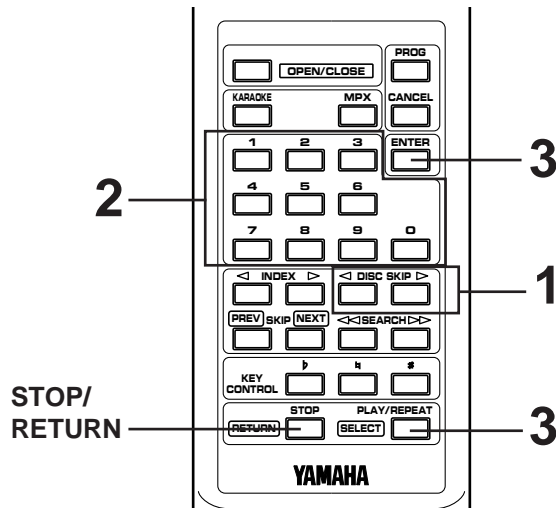

1 If necessary, select a desired disc.

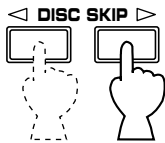

* If you want to play from the first track on the disc, press the **PLAY/REPEAT** button.

2 Select a desired track number.

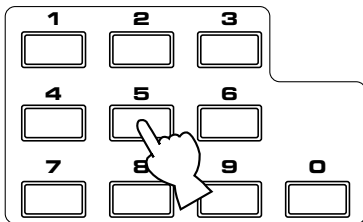

3 Start play.

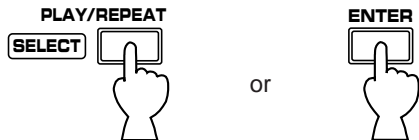

Selecting a track (by using the numeric buttons)

For example:

To select track 5
Press "5".

To select track 12
Press "1", then press "2".

To select track 20
Press "2", then press "0".

Note

If a track number higher than the highest track number on the disc is selected, the last track on the disc will be played.

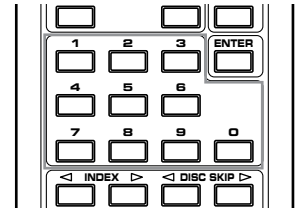

Display information

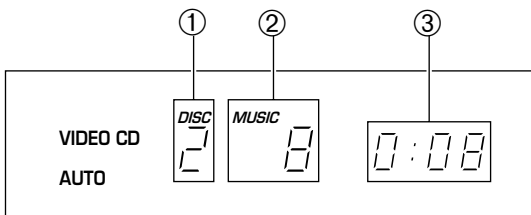

- ① Shows the tray number of the selected disc.
- ② Shows the selected track number.
- ③ Shows the elapsed time of the selected track.

Note

If a Video-CD, version 2.0 is selected, "PBC" lights up on the display. In this mode, disc play is controlled by the rule of Playback Control. (For details of Playback Control, refer to page 16–18.)

To cancel this mode and restore the normal play mode, press and hold the **STOP/RETURN** button for more than 2 seconds. "PBC" disappears from the display.

To call the Playback Control mode again, press and hold the **STOP/RETURN** button for more than 2 seconds.

To replay from the beginning of the track currently playing

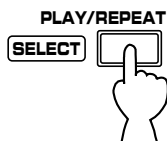

To skip to the beginning of a desired track

- To play from the beginning of the track following the one currently playing

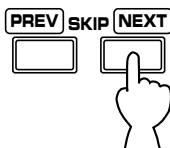

- To play from the beginning of the track currently playing

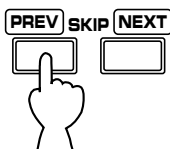

- To play from the beginning of the track before the one currently playing

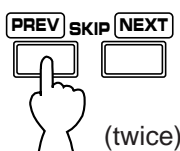

Notes

- These operations can also be performed when the unit is in the pause or stop mode.
 - When using the **SKIP** buttons on the remote control transmitter:
 - If a button is pressed and held, the track number is continuously changed to higher numbers (or lower numbers).
- When using the **SKIP/SEARCH** button on the front panel: Be careful not to press and hold the button, otherwise the selected track is played forward (or backward) rapidly.

To advance or reverse play rapidly (Manual search)

To advance rapidly

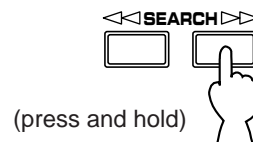

To reverse rapidly

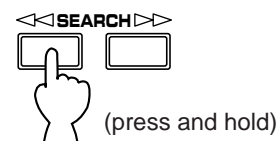

- The sound can be heard (although slightly garbled) during manual search in either direction. This is convenient for locating a precise position within a track, or for reviewing the contents quickly.
- Manual search can also be performed while disc play is paused, though no sound will be heard.
- When using the **SKIP/SEARCH** button on the front panel: Be careful not to release the button just after it is pressed, otherwise the play is skipped to the beginning of the next track or returned to the beginning of the current track.

To enter the KARAOKE mode

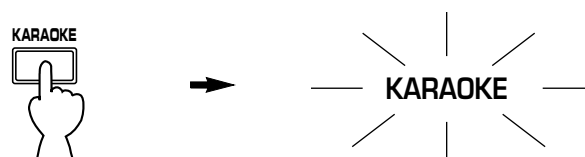

- A pause is inserted each time a play of track ends. To begin playing the next track, press the **PLAY/REPEAT** button. While this unit is paused, “:” flashes on and off on the time display.
- In this mode, you can program tracks for singing Karaoke. See page 13–15 for details.
- Some adjustments can be made on this unit for enjoying Karaoke. See the next page for details.

Notes

- If “PBC” is illuminated on the display, pressing the **KARAOKE** button to enter the Karaoke mode will cancel the Playback Control mode (turn “PBC” off) and stop this unit.
- If the pause mode is engaged for 10 minutes, the unit is stopped automatically to protect the internal mechanism.

To cancel this function

Press the **KARAOKE** button again. “KARAOKE” disappears from the display.

* If a Video-CD, version 2.0 is selected at this time, “PBC” lights up on the display and this unit stops.

Adjustments for enjoying Karaoke

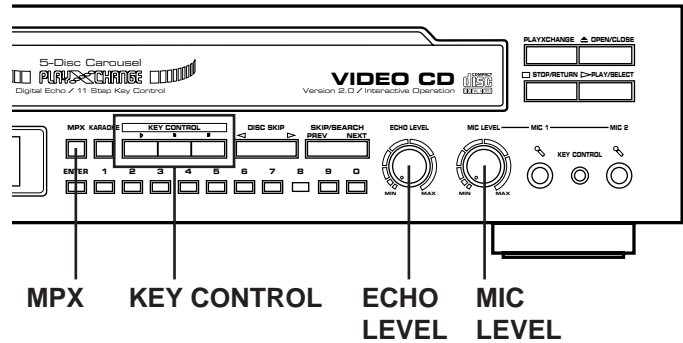
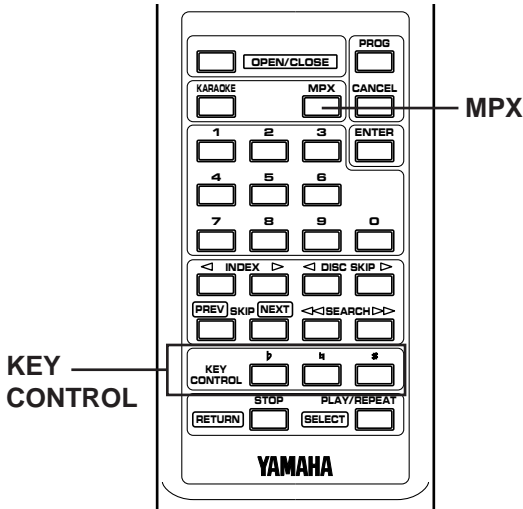

Adjusting the level of sound signals input from the microphone(s)

MIC LEVEL

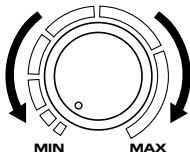

Turning the **MIC LEVEL** control clockwise increases the level, and counterclockwise decreases the level.

Adjusting the level of echo applied to sound signals input from the microphone(s)

ECHO LEVEL

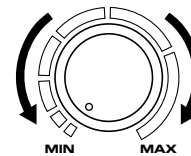

Turning the **ECHO LEVEL** control clockwise increases the level, and counterclockwise decreases the level. If you need no echo effect, set this control to the "MIN" position.

Changing audio output mode

You can select any of four audio output modes by pressing the **MPX** button.



Display indication	Audio output mode
L R	Normal stereo output
L	Sound from the left channel only is output from both the left and right speakers.
R	Sound from the right channel only is output from both the left and right speakers.
VC	Sound of vocals on the source is attenuated. * There may be a case that vocals cannot be attenuated effectively according to a source.

Adjusting key of the track currently playing

Pressing the **KEY CONTROL** buttons change key of the track currently playing. The current key level is shown on the display. Whenever a track changes, its original key level is restored.

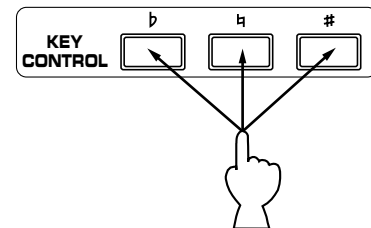

- b** : Whenever pressed, key of the track becomes lower in 5 steps.
- h** : Pressing this button restores the original key level of the track.
- #** : Whenever pressed, key of the track becomes higher in 5 steps.

PRE-PROGRAMMING SELECTIONS (FOR SINGING KARAOKE)

- Programming is possible either while the unit is playing a disc or stopped.
- As many as 10 selections can be stored at one time.

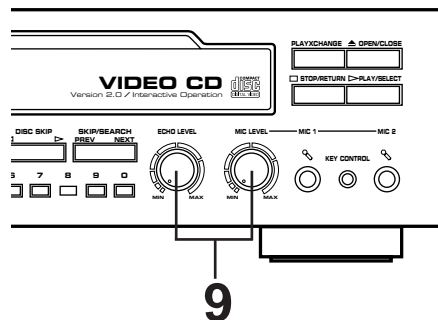
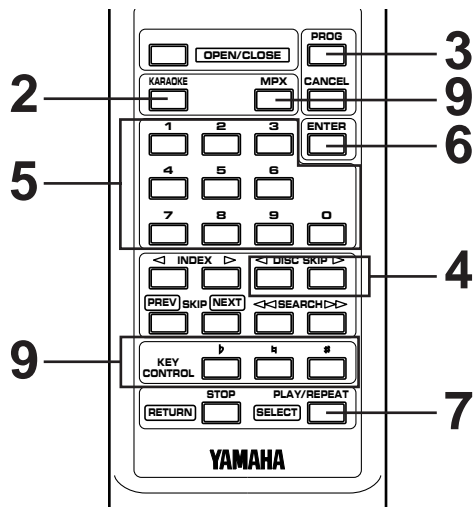

1 Load discs on the disc tray.

2 Press the **KARAOKE** button so that "KARAOKE" lights up on the display. To cancel it, press the **KARAOKE** button once again.

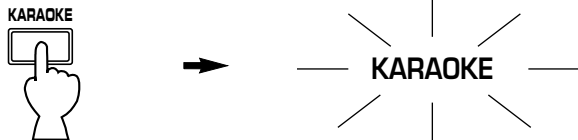

3 Press the **PROG** button. The display flashes.

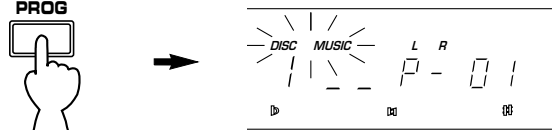

4 Select the disc (before "DISC" and "MUSIC" stop flashing on the display).

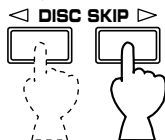

5 Select the track (before "DISC" and "MUSIC" stop flashing on the display).

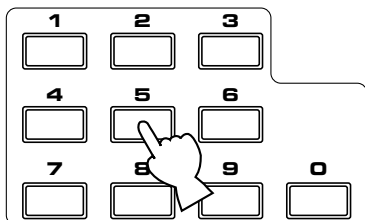

7 To start play, press the **PLAY/REPEAT** button.

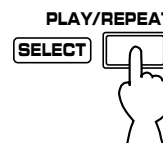

* This unit pauses whenever a play of track ends. To start playing the next track, press the **PLAY/REPEAT** button.

8 Repeat step 3–6 to program more selections.

9 If necessary, change the audio output mode by pressing the **MPX** button. Use the **KEY CONTROL** buttons and the **MIC LEVEL** and **ECHO LEVEL** controls as you prefer. (See page 12 for details.)

Notes

- In step 4 or 5, if "DISC" and "MUSIC" stop flashing on the display before you finish programming a track, press the **PROG** button again.
- If you program a track number which is higher than the highest track number on the disc, "E r r" appears on the display and it cannot be programmed.
- This unit can store as many as 10 selections at one time. If you program a track number as the eleventh program, "E r r" appears on the display and no more program can be made.

Display information during programming

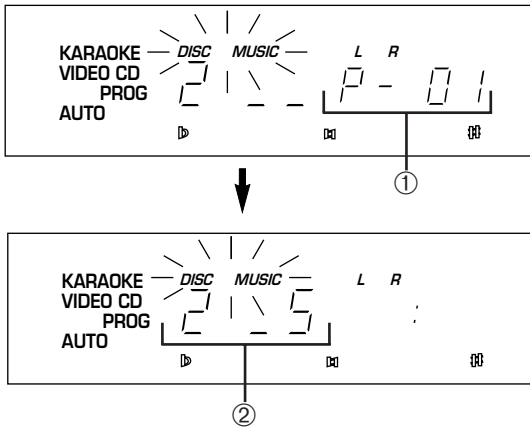

- ① Shows the program number for the track to be programmed next.
- ② Shows the selected disc and track number.

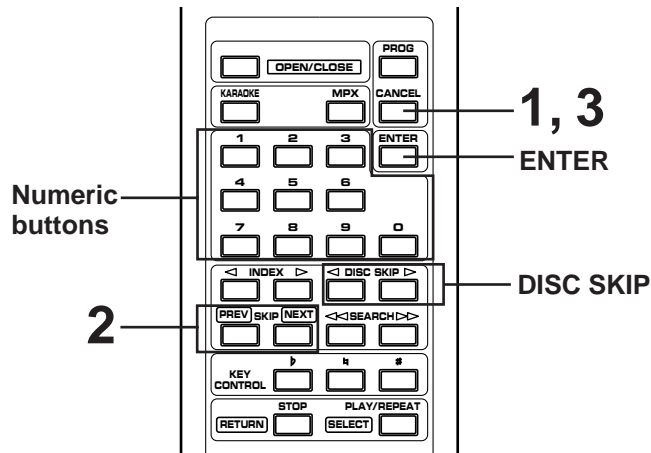

To check program data

1



The disc number, the track number and the program number of the last selection will flash on the display.

2

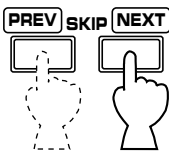

Each time the **SKIP** >> button is pressed, the disc numbers, the track numbers and sequential order of the programmed tracks can be checked one after another. The display of the track number can be returned (sequentially in reverse order) by pressing the **SKIP** << button.

3

When the check is completed;





To correct the selection currently playing

There are two methods, as described below.

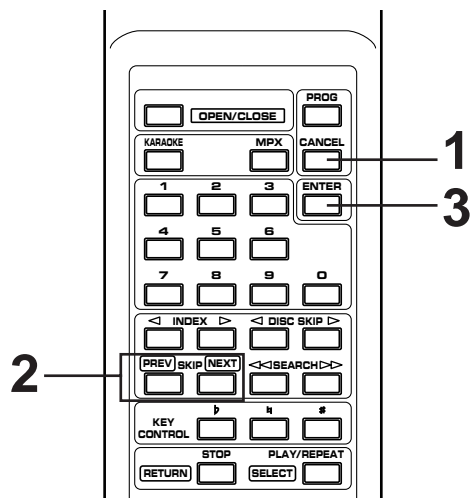
- 1) Select the track to replace the one currently playing by using the **DISC SKIP** button and the numeric buttons, then press the **ENTER** button.
- 2) Select the track to replace the one currently playing by using the **DISC SKIP** button and the **SKIP** buttons.

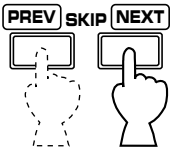

To cancel a programmed selection

1	
	The disc number and the track number of the last selection will flash on the display.
2	
	Display the disc number and the track number to be canceled.
3	
	Press once while the number is flashing.

To cancel the selection you are currently programming

There are two methods, as described below.

- 1) Press the **CANCEL** button instead of the **ENTER** button after the track number is selected.
- 2) If about 30 seconds pass with no operation after the track number is selected, the track will not be programmed.

To cancel all program data

Switch off the power.

Notes

- The **SEARCH** buttons can be used during play to search all tracks including tracks not programmed.
- When programs consist of tracks from more than one disc, if you change a disc by using the **PLAYXCHANGE** button, the programmed track on the removed disc is replaced by the same numbered track on the new disc.

If the same number of the programmed track does not exist on the new disc, the program will substitute the highest-numbered track on the new disc.

EXAMPLE:

Program	<u>Swap disc 4 (new disc has 9 tracks only)</u>
Disc 1, Track 5	Disc 1, Track 5
Disc 2, Track 8	Disc 2, Track 8
Disc 4, Track 12	Disc 4, Track 9

PLAYBACK CONTROL OF VIDEO-CD (Ver. 2.0)

This function is available for Video-CDs, version 2.0 only. "PBC" will light up on the display when a version 2.0 disc is used.

The Playback Control differs with each disc. This section gives a basic explanation of Playback Control. Refer to the instruction manual for the disc for details.

Playback Control provides you with two types of new playback enjoyment.

Playback selection on a screen menu

You can select pictures, music and information to play back by selecting items on a screen menu. (Similar to having a conversation.)

Playback of high quality pictures

You can enjoy watching pictures which are four times higher in quality than moving pictures.

A Flowchart of Playback Control (as an example)

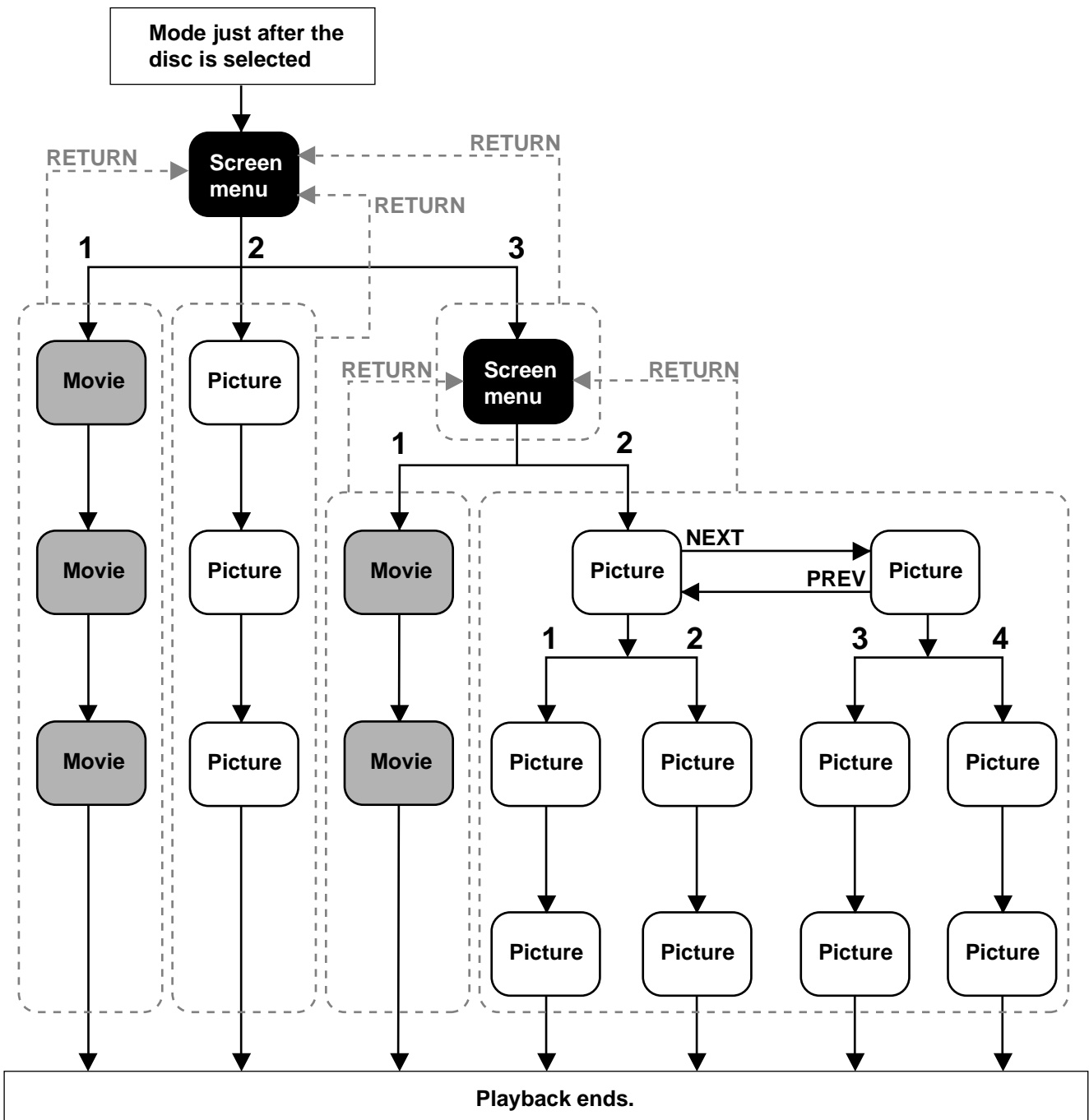

Basic operation

Note

Disc play in the Playback Control mode depends on the data of the disc used. So, according to the contents of disc, the following operating method may not be applied to the disc. Be sure to refer to the instruction manual for the disc.

Before operation

If "KARAOKE" is illuminated on the display, press the **KARAOKE** button to cancel it.

(When "KARAOKE" is illuminated, a Playback Control operation cannot be made.)

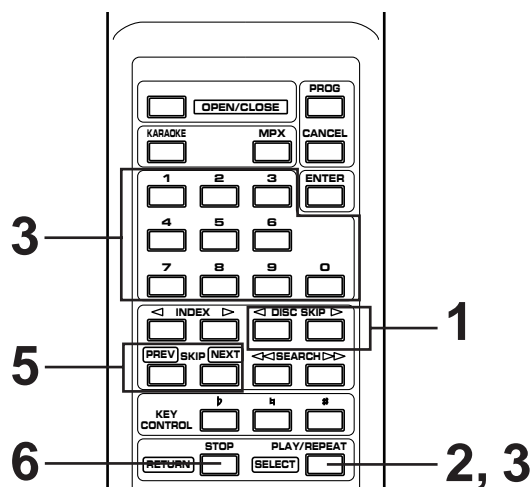

- 1** Stop this unit and select a Video-CD (version. 2.0).

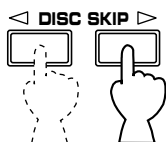

- 2**
-
- A hand is shown pressing the 'PLAY/REPEAT' button on the remote control.

A screen menu appears.

- * Some discs show several short movies sequentially instead of a menu.

- 3** Select the number of item you want to play.

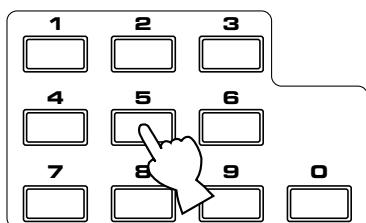

- * If the disc shows several short movies sequentially, press the **PLAY/REPEAT** button when a desired picture appears.

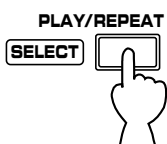

- 4** Play starts, or another menu appears. If another menu appears, repeat step 3.
(Some discs have more than one screen menu.)

- 5** If "NEXT" or "▶▶" appears on the screen during play, pressing the **NEXT** button will change to the next menu.

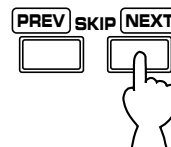

If "PREV" or "◀◀" appears on the screen during play, pressing the **PREV** button will restore the previous menu.



- 6** If the play has finished, press the **STOP/RETURN** button once or more to return to a previous mode.

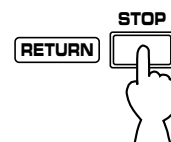

To select a number higher than 9 in step 3

Example)

- To select number 15
Press "0", "1" and "5" in succession.
- To select number 20
Press "0", "2" and "0" in succession.

To stop play

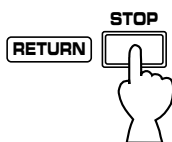

Press and hold for more than 2 seconds.

To return to a previous screen mode during play

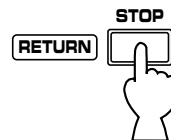

Press once.

* To return to the first screen mode, press the **STOP/RETURN** button repeatedly until the first screen mode appears.

If the disc has index numbers

Pressing the **INDEX** ◀ or ▶ button once or more searches for and select any index number. Play starts from the point of selected index number.

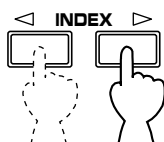

To play a Video-CD (ver. 2.0) without Playback Control operation

Press and hold the **STOP/RETURN** button for more than 2 seconds when this unit is stopped. "PBC" disappears from the display, and this unit turns into a normal play mode.

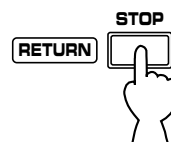

To restore the Playback Control mode again, press and hold the **STOP/RETURN** button for more than 2 seconds.

NOTES ABOUT THE REMOTE CONTROL TRANSMITTER

Battery installation

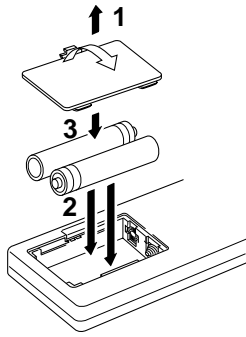

Battery replacement

If you find that the remote control transmitter must be used closer to the main unit, the batteries are weak. Replace both batteries with new ones.

Notes

- Use only AA, R6, UM-3 batteries for replacement.
- Be sure polarities are correct. (See illustration inside battery compartment.)
- Remove batteries if remote control transmitter will not be used for an extended period of time.
- If batteries leak, dispose of them immediately. Avoid touching the leaked material or letting it come in contact with clothing, etc. Clean the battery compartment thoroughly before installing new batteries.

Remote control transmitter operation range

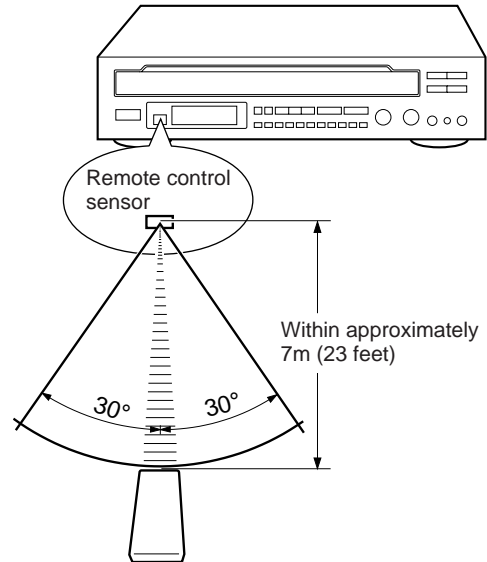

Notes

- There should be no large obstacles between the remote control transmitter and the main unit.
- If the remote control sensor is directly illuminated by strong lighting (especially an inverter type of fluorescent lamp etc.), it might cause the remote control transmitter to not work correctly. In this case, reposition the main unit to avoid direct lighting.

HANDLING COMPACT DISCS

- To remove a disc from its storage case, open the case and then press down at the center; with a finger through the center hole and the outer edges held as shown in the illustration, lift the disc out carefully.

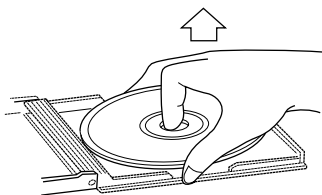

- Always handle the disc with care so that its surface is not scratched.

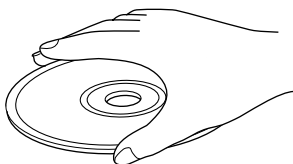

- Discs are not subjected to wear during play, but disc surface damage when the disc is being handled can adversely affect the disc's play.

- Discs are not affected by small particles of dust or fingerprints on their playing surface, but even so they should be kept clean. Wipe by using a clean, dry cloth. Do not wipe with a circular motion; wipe straight outward from the center.

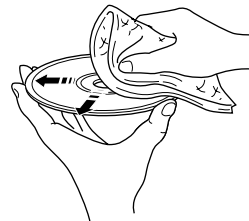

- Do not try to clean the disc's surface by using any type of disc cleaner, record spray, anti-static spray or liquid, or any other chemical-based liquid, because such substances might irreparably damage the disc's surface.
- Do not expose discs to direct sunlight, high temperature or high humidity for a long period of time, because these might warp or otherwise damage the disc.

No!



To play a 8-cm (3-inch) CD

Place it in the inner recessed area of the disc tray. Do not put a normal (12-cm/5-inch) CD on top of a 8-cm CD.

TROUBLESHOOTING

If the unit fails to operate normally, check the following points to determine whether the fault can be corrected by the simple measures suggested. If it cannot be corrected, or if the fault is not listed in the SYMPTOM column, disconnect the power cord and contact your authorized YAMAHA dealer or service center for help.

SYMPTOM	PROBABLE CAUSE	REMEDY
This unit does not switch ON when the POWER switch is pressed.	The power cord is not connected or not completely connected.	Securely connect the power cord.
The disc tray does not close completely.	A foreign object is obstructing the tray.	Carefully check the disc tray and remove the foreign object.
Play does not begin.	The disc is damaged.	Check the disc carefully; replace it if necessary.
	There is moisture on the laser pickup.	Wait 20 to 30 minutes after switching the unit ON before trying to play a disc.
	The disc has been loaded upside down.	Reload the disc with the label side up.
	The disc is dirty.	Clean the disc.
Play is delayed, or begins at the wrong place.	The disc may be scratched or damaged.	Check the disc carefully; replace it if necessary.
A disc cannot be played normally, or there is a noise during play.	A nonstandardized disc is played.	Play another disc.
No sound or no picture.	Improper output cable connections.	Connect the cables properly. If the problem persists, the cables may be defective.
	Improper amplifier operation.	Set the amplifier controls to the correct input selection.
No picture.	The setting of the VIDEO OUT MODE SELECT switch is improper.	Set the VIDEO OUT MODE SELECT switch to another proper position.
Sound and picture "skip".	This unit is being subjected to vibrations or impacts.	Relocate this unit.
	The disc is dirty.	Clean the disc.
Sound "hums".	Improper cable connections.	Securely connect the audio cables. If the problem persists, the cables may be defective.
Noise from a nearby tuner.	The tuner is too close to this unit.	Move the tuner and this unit farther apart.
Noise from inside of the disc tray.	The disc may be warped.	Replace the disc.
The remote control transmitter does not work.	The batteries of this remote control transmitter are too weak.	Replace the batteries with new ones.
	Direct sunlight or lighting (of an inverter type of fluorescent lamp etc.) is striking the remote control sensor of the main unit.	Change position of the main unit.

SPECIFICATIONS

Audio (analog) output 2 pairs of terminals
 Audio (analog) output level
 1 kHz, 0 dB 2 ± 0.5V
 Video output
 75Ω, Negative sync. 2 terminals
 Video output level 1 Vp-p
 Mic input 2 jacks
 Signal processing
 KEY CONTROL, ECHO Digital

Power requirements
 China model AC 220V, 50 Hz
 Singapore model AC 230V, 50 Hz
 General model AC 110/120/220/240V, 50/60 Hz
Power consumption 25W
Dimensions (W x H x D) 435 x 106 x 388 mm
Weight 6.5 kg
Accessories Audio connection cord x 1
 Video connection cord x 1
 Remote control transmitter
 Batteries (size AA, R6, UM-3)

Please note that all specifications are subject to change without notice.

YAMAHA

YAMAHA ELECTRONICS CORPORATION, USA 6660 ORANGETHORPE AVE., BUENA PARK, CALIF. 90620, U.S.A.
YAMAHA CANADA MUSIC LTD. 135 MILNER AVE., SCARBOROUGH, ONTARIO M1S 3R1, CANADA
YAMAHA ELECTRONIK EUROPA G.m.b.H. SIEMENSSTR. 22-34, D-25462 RELLINGEN BEI HAMBURG, F.R. OF GERMANY
YAMAHA ELECTRONIQUE FRANCE S.A. RUE AMBROISE CROIZAT BP70 CROISSY-BEAUBOURG 77312 MARNE-LA-VALLÉE CEDEX02, FRANCE
YAMAHA ELECTRONICS (UK) LTD. YAMAHA HOUSE, 200 RICKMANSWORTH ROAD WATFORD, HERTS WD1 7JS, ENGLAND
YAMAHA SCANDINAVIA A.B. J A WETTERGRENS GATA 1, BOX 30053, 400 43 VÄSTRA FRÖLUNDA, SWEDEN
YAMAHA MUSIC AUSTRALIA PTY, LTD. 17-33 MARKET ST., SOUTH MELBOURNE, 3205 VIC., AUSTRALIA

YAMAHA CORPORATION

VV00810